



DISPENSING PERSITALTIC PUMP LBX P10 Compact

Please read the User Manual carefully before use, and follow all operating and safety instructions!

USER MANUAL

PART 1 Matters needing attention

>>Matters needing attention

Please read the operating instruction manual carefully before operating this equipment.

◆ Safety:

- 1.The staff responsible for the installation or maintenance of this equipment should have the experience and ability to carry out related work.
- 2.This product is not applicable to the ATEX explosion-proof directive and cannot be used in flammable and explosive environments.
- 3.When pumping dangerous liquids, please follow safety precautions.
- 4.Please determine whether you need to wear personal protective equipment when operating the pump in accordance with the nature of the transfer fluid and industry specifications.
- 5.Non-professionals should not install this pump with other equipment to reduce safety risks.
- 6.For hazardous fluids, a dedicated operation process must be specified to prevent personal injury.
- 7.The power plug can disconnect the power supply and drive in an emergency. Do not place the pump in a workplace where it is difficult to cut off the power supply, otherwise it will affect the emergency stop operation.

◆ Tube:

- 1.In the event of a tube failure, ensure that the fluid in the pump tube of the pump head can be discharged to a suitable container or drain.
- 2.A ruptured tube may cause fluid to splash. Please take appropriate protective measures.
- 3.When disassembling the tube, it is necessary to drain the medium and cut off the power supply to ensure that the pipeline is pressure-free.
- 4.Ensure that the chemicals to be handled are compatible with the pump head, tubes and accessories.

◆ Roller :

- 1.Do not touch the rollers while the pump is running.
- 2.Keep the rollers clean and dry to reduce tube wear.
- 3.Do not lubricate the pump head rollers by yourself. Improper operation may cause the tube to run out or the pump head shell to corrode.

◆ Drive:

1. There are no user-serviceable parts in the pump.
2. The power socket on the back of the driver is equipped with a user-replaceable built-in fuse. Only products of the same category can be used to replace the fuse.
3. The surface of the driver and the pump head are not resistant to organic solvents and strong corrosive fluids. If the liquid is splashed or accumulated, please remove and clean it in time.
4. After the pump enters the external control mode. The external control icon in the upper right corner of the LED screen lights up, and the pump can realize start&stop/direction/speed control in the external control mode.

PART 2 Unboxing

>>Unboxing

2.1 Unpacking inspection

Confirm that the pump is packaged in good condition. Please check the packing list, when unpacking, check the product model and the number of accessories, and check whether the parts are damaged during transportation. If you have any questions, please contact us immediately.

The packing list is sent with the goods, and the actual delivery content is subject to the list.

2.2 Product storage

This product can be stored for a long time, but before putting it into operation, please confirm that the drive, pump head or tubes and other accessories can be used normally. The tubes are commonly used consumables. Pay special attention to the use time and expiration date.

PART 3 Product description

>>Product description

3.1 Principle of Peristaltic Pump Operation

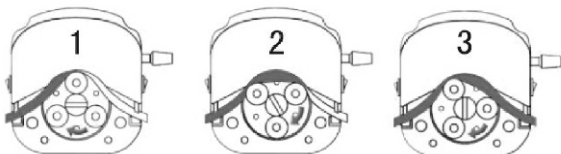

- ◆ The peristaltic pump uses the rotor to alternately squeeze and release the tube to transfer fluid, just like squeezing a tube full of fluid with a finger. As the finger slides forward, when a negative pressure is formed in the tube, the liquid flows with it.

3.2 Product features

- ①LED digital display: 4-digit LED digital display speed and flow, with flow calibration function
- ②One button full speed: There is a convenient full speed button for quickly filling or emptying the pipe
- ③Easy to operate: adjust the parameters by pressing the button, it can run in both positive and negative directions, and the operation is simple
- ④External control function: support RS485/MODBUS communication protocol, the protocol can also be customized according to customer needs
- ⑤Power-off save: can automatically save the control parameters of the last power-off
- ⑥Flow calibration: flow calibration can be carried out, and the suction function can be provided to prevent liquid leakage.

3.3 Product structure

· Drive

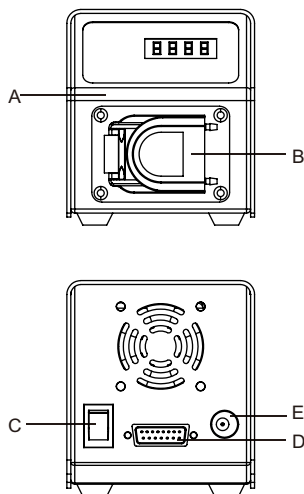

A: Drive B: Pump head C: Power switch D: External interface E: Power interface

· Pump head/tube selection and reference flow

[Stepping microfluidic peristaltic pump P10 Compact can match the pump head]

Pump head	Model	Rollers	Tube	ID*wall thickness (mm)	Max Speed (rpm)	Max flow (ml/min)
	WP110	3	1*1	1*1	100	5.16
			2*1	2*1	100	17.01
			3*1	3*1	100	28.25
		4	1*1	1*1	100	4.63
			2*1	2*1	100	12.34
			3*1	3*1	100	24.42
		6	1*1	1*1	100	3.75
			2*1	2*1	100	13.02
			3*1	3*1	100	17.90

Note: The test environment for flow data is normal temperature and pressure, and the test fluid is water. The values are for reference only, please refer to the actual situation.

3.4 Technical parameter

Drive type	P10 Compact
Max speed	100rpm(reversible)
Speed resolution	0.1rpm
Max flow	28.25ml/min
External control method	Membrane key adjustment
Display mode	4-digit LED displays current speed/flow
Return suction speed	10-100rpm
Power Supply	AC220V±10% (Standard) or AC110V±10% (optional)
Power	<22W
Working environment	0-40°C
Drive size(mm)	120x100x108 mm
Speed control mode	Start control/direction control/speed control(0-5V, 0-10V, 4-20mA optional) RS485 serial communication

PART 4 Product installation

>>Product installation

4.1 Installation suggestions and precautions

Installation suggestions

- >> Application accessories such as foot switch, countersunk head, check valve, filling nozzle, connector, etc. can be selected according to actual conditions.
- >> For the size and selection of the tube, please refer to 3.3 Product Structure • Pump head/tube selection and reference flow Related Content.
- >> For pump head models and options, please refer to 3.3 Product Structure • Pump Head/tube Selection and Reference Flow Related Contents.

- ① Before cleaning, maintaining and installing the equipment, be sure to disconnect the control power supply;
- ② The driver should be placed on a flat and rigid surface;
- ③ The ambient temperature of the pump should not exceed 104° F (40° C), and air circulation should be ensured to ensure the heat dissipation of the pump;
- ④ The start-stop key (shortcut key) on the operation panel can quickly change the direction and control the start-stop, but it is recommended to install an emergency stop device on the main circuit of the power supply to ensure higher safety;
- ⑤ Make sure that the inner wall of the tube is clean and free of foreign matter before use. The shorter the pipeline, the better, and the suction and lift should not be too long;
- ⑥ Determine the running direction of the pump (forward and reverse) according to the specific location of the fluid placement and supporting machinery on site, which is conducive to later operation;
- ⑦ In order to meet the requirements of flow and flow rate, a peristaltic pump tube with matching diameter is required;
- ⑧ The pump itself has self-priming characteristics, which can effectively prevent the backflow of liquid. Generally, there is no need to install valves at the outlet and inlet of the tube. You can also install a one-way valve in the pipeline according to actual needs to avoid fluid leakage when the pump head and tube fail.

Precautions

- The diameter of the pipeline at the inlet is not less than the inner diameter of the pump tube, and a delivery pipe with a diameter \geq the inner diameter of the pump tube should be selected.



- When transferring viscous liquids, it is necessary to maintain a low speed operation to improve the filling efficiency. It is recommended to connect a flexible tube no less than 1 meter between the inlet and the outlet to reduce the pulse and reduce the pulse loss.
- Try to put the pump at the same level or a lower level of the liquid to be transferred to improve the transfer efficiency of the pump.
- To replace a new tube or liquid, re-calibrate the liquid volume to ensure the accuracy of liquid transmission.
- When the peristaltic pump is running, all valves in the pipeline must be opened normally.
- Control wires and power wires are not allowed to have sharp bends, and it is not recommended to bundle them together.
- This product cannot be used for the transmission of any chemical substances incompatible with the pump head and tube.

PART 5 Product operation

>>Product operation

5.1 Line connection

Power connection:

-  AC220V \pm 10% (standard) power supply or AC110V \pm 10% (optional) power supply.
-  Ensure that all power supplies are matched to equipment power and are well grounded.
-  The position of the pump should ensure that it is convenient to disconnect the power supply when operating the equipment.

Power supply wiring diagram: **External control wiring diagram:**

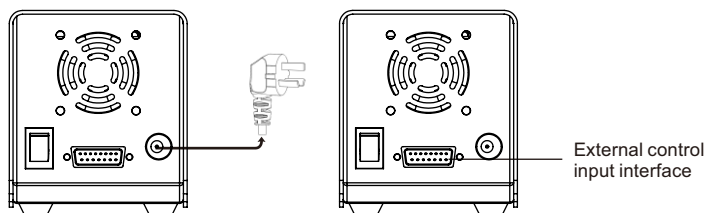

Note: For the specific external control input/output interface definition, please refer to "5.7 External Control Operation" for details

5.2 Power-on

· Power-on inspection

- ① Check whether the pump pipe has been installed correctly, and whether the tube inlet pipe and outlet pipe have been correctly connected.
- ② Check whether it is connected to a matching power supply.
- ③ Check whether the peristaltic pump has been installed according to "4.1 Installation suggestions and precautions".

After the pump is turned on, the LED display will light up and you can start specific operations and settings.

5.3 Operation panel and display

· Operation panel

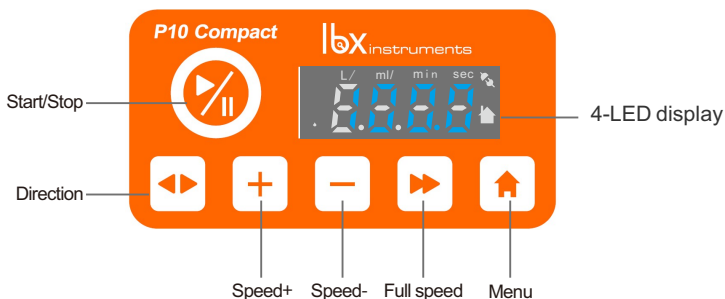

· Digital Display

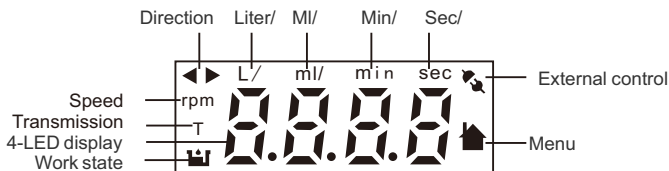



4-LED display screen, different icons light up, it shows the current working status of the pump

5.4 Quick operation



*Switch

After confirming that the power plug is installed correctly, press the switch on the back of the driver  , "I" means power on, and "O" means power off.



*Start-stop direction control

When the pump is stopped, press the start/stop button  Pump starts. With the pump running, press the start/stop button. 



*Speed function

Press  button LED speed/flow display increments; Press  LED speed/flow display decreases.



*Menu operation function

When the pump is stopped, press the menu button  enter menu, press  
Press the key to select the corresponding option, and press the Menu key to confirm.

*Full speed function

When the peristaltic pump is running at the displayed speed, press the full speed button  Pump runs at maximum speed (100rpm), Show "FULL". Complete quick emptying, filling or cleaning operations; Press the full speed button again  , The pump resumes operation as it did before entering full speed.

*Direction switching function

When the pump is stopped and running, press the direction button  , The pump runs in the opposite direction, the LED shows the direction of change, Press the directional button again  , The pump switches to the original direction, and the LED shows the change direction.

5.5 Application case

Application 1: speed mode transmission (Transmission fluid to rotate speed of 80rpm/min.)

- (1) Press the menu key to enter (Display mode selection)
- (2) Press "+" or "-" to adjust to enter (Speed display mode)
- (3) Press the menu key to confirm that the current mode is the speed display mode
- (4) Press "+" or "-" to adjust to and press the menu key (return to the main interface)
- (5) Press "+" or "-" to adjust to
- (6) Press the "Start/Stop" button, the peristaltic pump runs at 80rpm/min.

Application 2: flow mode transmission (Transmission fluid to rotate speed of 8ml/min.)

- (1) Press the menu key to enter (Display mode selection)
- (2) Press "+" or "-" to adjust to enter (Flow display)
- (3) Press the menu key to confirm that the current mode is the flow display mode.
- (4) Press "+" or "-" to adjust to and press the menu key (return to the main interface)
- (5) Press "+" or "-" to adjust to
- (6) Press the "Start/Stop" button, the peristaltic pump runs at 8mL/min.

Application 3: calibration fluid (With 8 ml/min speed transmission fluid.)

- (1) Switch the peristaltic pump to flow mode.
- (2) Users need to choose the number of pump head rollers and pump tubes correctly according to their own situation. If the user chooses the 3 rollers and 2*1 tube of the WP110 pump head, you need to first Choose A210, then in Select -2.0-.
- (3) After returning to the main interface, adjust the flow to 8ml/min. If the accuracy cannot meet the user's needs, flow calibration is required.
- (4) Press the menu key to enter 8.000ml is displayed at this time.
- (5) Press the "Start/Stop" button, the peristaltic pump will carry out liquid transfer, and the peristaltic pump will automatically stop and display after the timer expires.

(6) Press the start/stop button to display 8.000mL, at this time adjust the actual test liquid volume by pressing the buttons "+" and "-" (eg: 8.500mL), then press the menu key to confirm, show 

(7) Press "+" or "-" to make the screen display ESC, press the "Menu" button to confirm the return to the main interface, complete calibration.

Note: If the actual liquid volume accuracy does not meet the requirements, you can enter E0-- and repeat the calibration several times.

Application 4: Foot switch (only controls start and stop)

(The liquid is transferred at a flow rate of 200ml/min, and the foot switch controls the start and stop)

(1) Press the menu key to enter  (Display mode selection)

(2) Press "+" or "-" to adjust to enter  (Flow display)

(3) Press the menu key to confirm that the current mode is the flow display mode.

(4) Press "+" or "-" to adjust to  and press the menu key (return to the main interface)

(5) Press "+" or "-" to adjust to 200.

(6) Press the menu key and press "+" or "-" to  (External control, system settings)

(7) Press the menu key to enter  (speed control selection) Press "+" or "-" to adjust to C0-4 (internal control speed)

(8) Press the menu key to enter  (Start and stop control selection) Press "+" or "-" to adjust to C2-1 (external control start and stop)

(9) Use the direction keys on the operation panel to control the running direction

(10) Press the menu key to return to the main interface

Note: Start-stop signal mode, the default is level mode.

* First boot default factory settings

Factory setting: P10 Compact peristaltic pump, the factory setting display mode is speed mode, pump head model is WP110, tube model is 2*1, if there is a need for replacement, need to contact us.

Note: The factory settings can be adjusted according to the actual needs of customers.

Operation instruction details 5.6 Menu function operation

(If it is not necessary, please do not adjust the parameter items at will)

Device address selection	1	Boot display
Default display mode	Speed mode	A0-0
External control speed mode	0-5V control	C0-0
External control direction mode	External control direction	C1-1
External control Start&Stop mode	External control start & stop	C2-1
Start-stop signal mode	level mode	C3-0
Initial state of pulse signal	Stop	C5-0
Communication baud rate	9600	A1-6 : 9600
Suck back speed selection	10rpm	A1-8 : 10
Suck back angle selection	0° (No suck back)	A1-9 : 0
485 enable selection	485 disabled	Co-0
External control output setting	0-5V output	Cb-0
External control start-stop line selection	1 is valid	Cd-0
Pump head setting	WP110	A210
Pump tube setting	2*1	A2-1 : -2*1-

*After the pump is turned on, it runs according to the default setting. All operating parameters can be changed by adjusting the button (5. 6 Menu function operation)

5.6 Menu function operation

- ① Press the menu button to enter the first-level menu from the main interface: A0- - / A1- - / A2- -
- ② Press "+" or "-" to adjust, press the menu key to confirm, enter the secondary menu Ax-x (If the operation option is up to level 2, select and confirm, that is, the function setting is completed. To exit, press "+" or "-" to adjust to ESC, and press the menu key to exit.)
- ③ Press "+" or "-" to adjust the selection, press the menu key to confirm, and enter the third-level menu.....
- ④ Press "+" or "-" to adjust the selection, press the menu key to confirm, complete the function setting, then press "+" or "-" to adjust to ESC, and then press the menu key to exit step by step.

*Boot display, Device address (1-30)

Boot display

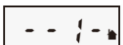

Main interface

First level menu → second level menu → third level menu



→ *Display mode selection: A0 - -

① Speed display →

② Flow display →



→ *External control, system setting: A1 - -

(1) Speed control method selection

→

- C0-0 0-5V control
- C0-3 0-10kHz control
- C0-10 -10V control
- C0-4 Internal control speed
- C0-2 4-20mA control
- ESC

(2) Direction control method selection

→

- C1-0 Internal control direction
- C1-1 External control direction
- ESC

(3) Start&stop control method selection

→

- C2-0 Internal control direction Start&stop
- C2-1 External control direction Start&stop
- ESC

(4) Start-stop signal mode selection

→

- C3-0 Level mode
- C3-1 Pulse mode
- ESC

(5) Signal action mode

→

Level, pulse signal selection

- C4-0 Low level/Falling edge start
- C4-1 High level/Rising edge start
- ESC

(6)Initial state pulse signal $\boxed{P1--a} \rightarrow \boxed{P1-5a} \rightarrow$

- C5-0 Stop
- C5-1 Run
- ESC

(7)Communication baud rate selection $\boxed{P1--a} \rightarrow \boxed{P1-6a} \rightarrow$

- 1200
- 2400
- 4800
- 9600
- ESC

(8)Device address selection $\boxed{P1--a} \rightarrow \boxed{P1-7a} \rightarrow$

- -01- Choose address as (1)
- -30- Choose address as (30)
- ESC

(9)Suck back speed selection $\boxed{P1--a} \rightarrow \boxed{P1-8a} \rightarrow$

- 10-100
- ESC

Resolution 1rpm

(10)Suck back angle selection $\boxed{P1--a} \rightarrow \boxed{P1-9a} \rightarrow$

- 0, 10-720°
- ESC

Resolution 1°

(11)485 enable selection $\boxed{P1--a} \rightarrow \boxed{P1-0a} \rightarrow$

- Co-0 (485 disabled)
- Co-1 (485 enable)
- ESC

(12)Restore factory settings $\boxed{P1--a} \rightarrow \boxed{P1-c} \rightarrow$

- Cc-0 (Restore calibration K value)
- Cc-1 (Restore factory settings)
- ESC

(13)External control start-stop line selection $\boxed{P1--a} \rightarrow \boxed{P1-d} \rightarrow$

- Cd-0 (valid)
- Cd-1 (Invalid)
- ESC



→ *Pump head and pump tube setting: A2--

Note:This menu is displayed in flow mode

(1) pump head setting → →

- A210(3 rollers)
- A211(4 rollers)
- A212 (6 rollers)
- ESC

(2) pump tube setting → →

- -1*1-
- -2*1-
- -3*1-
- ESC



→ *Calibration function: E0--

Calibration function →

- Set the calibration fluid volume
- Start/stop key operation
- Actual value input
- Press the menu button to confirm completion

(P12 Application 3)



→ *Exit display:ESC



Exit display

Instruction manual:

* When A0-0 (speed display) mode is selected, A1 option menu (external control, system setting) can be opened.

* When A0-1 (flow display) mode is selected, the A1 option menu (external control, system setting), A2 (pump head and pump tube setting), E0 (calibration function) can be opened.

5.7 External control operation

-  Please provide the correct signal to the pin, do not exceed the specified range of the signal value, and do not connect the power supply voltage to other pins to avoid permanent damage.
-  Make sure that the end of the multi-strand cable is fastened with a cable tie to prevent the risk of electric shock.

DB15 The external control interface sketch

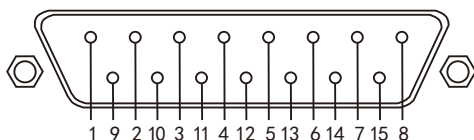

The external control interface sketch

Drive external control interface (DB-15 description)

1、The using method of the external interface.

- (A) Enabled wire and Ground wire connect or shut, control the entry of the external control.
- (B) Start/Stop wire and Ground wire connect or shut, control the start and stop of the pump.
- (C) Direction wire and Ground wire connect or shut, control the running direction of the pump.
- (D) Between Speed wire and Ground wire, join up 0-5V, 0-10V, 4-20mA, 0-10kHz, etc. controlling wire signal.

• External control input

-External control input interface definition

PIN	1	2	3	4	5	6	7	8
DEFINITION	E-c Ground	485 interface A	E-c Ground		Direction	E-c Ground	0-10kHz Input	0-5V Input

9	10	11	12	13	14	15
485 interface B	E-c Ground	Start /stop 1	E-c Enable	E-c Ground	4-20mA Input	0-10V Input

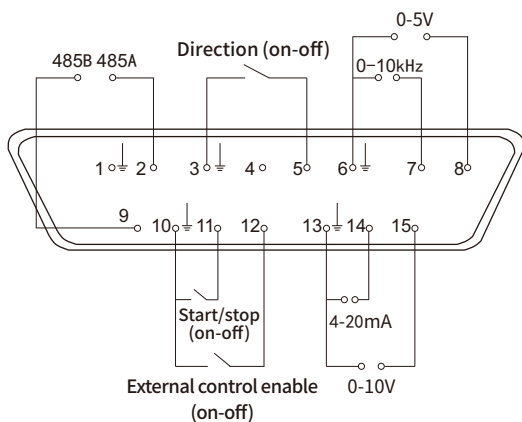

1, 3, 6, 10, 13 are all E-c Ground

External control input wiring diagram

[External control input line color function definition]

Serial number	Function	Corresponding function of wire
1	485 communication	Brown---485A Blue---485B
2	start/stop	Brown---start/stop Blue---E-c Ground
3	start/stop、direction	Brown---E-c Enable gray---start/stop Blue---direction black---E-c Ground
4	start/stop、analog input: (0-10kHz/0-5V/0-10V/4-20mA)	Brown---E-c Enable Gray---start/stop Blue--- 0-10kHz/0-5V/0-10V/4-20mA Black---E-c Ground
5	start/stop、direction、analog input: (0-10kHz/0-5V/0-10V/4-20mA)	Brown---E-c Enable Gray---start/stop Blue--- direction Two-color---0-10kHz/0-5V/0-10V/4-20mA Black---E-c Ground
6	start/stop、direction、analog input (0-10kHz/0-5V/0-10V/4-20mA)、485 communication	Brown---E-c Enable Gray---start/stop Blue--- direction Yellow---0-10kHz/0-5V/0-10V/4-20mA Green---485A Red---485B Black---E-c Ground
7	start/stop、485 communication	Brown---E-c Enable Two-color---start/stop Blue--- 485A Gray---485B Black---E-c Ground
8	start/stop、direction、485 communication	Yellow---E-c Enable Green---start/stop Red--- direction Blue---485A Gray---485B Black---E-c Ground

PART 6 Troubleshooting and maintenance

>> Troubleshooting and maintenance

Note: There are no parts in the pump that can be repaired by the user. If you need repairs, please contact the dealer or Labbox

6.1 Troubleshooting

*No response at boot	>>If a circuit protection device is installed, confirm that the circuit has not tripped >>Confirm that the power plug is inserted into a working socket >>Check whether the power cord is firmly inserted >>Check whether the fuse at the power interface is blown
*The fan and display screen are normal, but cannot be started	>> Check if the device is in external control mode >>Check if the keys are working
*The pump is turned on and the pump head cannot run	>>After cutting off the power, manually check whether the pump head is rotating normally >>Check if the coupling is damaged
* Low or no flow when the pump is running	>>Check whether the material supply is normal >>Check if the tube is entangled or blocked >>Check that all valves are open >>Check if the tube is in the middle of the roller >>Check whether the tube is cracked or damaged >>Check the running direction >>Check whether the pump head roller can rotate flexibly
*Pump cannot be controlled in external control mode	>> Check whether the external control icon  in the upper right corner of the LED display is on >> Check whether the external control settings are correctly connected >> Check if the signal source is normal

6.2 Product maintenance

· Basic maintenance and cleaning

Basic maintenance

- ① Open the pump head when it is not working to avoid tube deformation caused by prolonged extrusion.
- ② Keep the pump head rollers clean and dry to prevent surface damage and reduce tube wear; if there is splashing liquid, please wipe it dry as soon as possible.
- ③ Check the wear of the tube regularly and replace it in time to prevent leakage.
- ④ The pump head roller does not need to add lubricating oil, and improper operation may cause the tube to shift or corrode.
- ⑤ Not used to deal with chemical substances incompatible with the pump head or tube.
- ⑥ The pump head is not resistant to organic solvents and strong corrosive liquids. Please deal with it in time if there is effusion.
- ⑦ Please be aware of the storage recommendations and the expiration date of the tube so that it can be used normally after long-term storage.

Note: There are no parts in the pump that can be repaired by the user. If you need repairs, please contact the dealer or Labbox

Cleaning

Warning: Before attempting any maintenance, be sure to cut off the power to the pump. When there are stubborn stains on the pump housing, please use a mild detergent to scrub the surface. Do not immerse the pump in liquid or use too much liquid to clean it.

6.3 Warranty information

· Warranty commitment

The product is guaranteed for one year (consumables such as tubes are not included in the warranty). If there is a failure during the warranty period, you can enjoy free repair and replacement of parts; if it is damaged by man, it is not covered by the warranty.

- If the warranty period is exceeded, only the cost will be charged when repairing.
- There are no parts in the pump that can be repaired by the user. If you need repairs, please contact the dealer or Labbox

Note: Labbox does not guarantee the applicability of all its products, and any employee or distributor has no right to change or violate the above warranty clauses; Labbox is only responsible for repairing, replacing or replacing products in accordance with the actual situation and reasonable compliance requirements.

• Relevant details

· Labbox will not be responsible for any direct or indirect losses caused by external reasons such as operating errors or human negligence that are not the product's own quality problems.

Direct loss: products, supporting machinery, working environment, surrounding buildings, etc.

Indirect loss: labor loss, profit loss, etc.

- Labbox will not be responsible for the transportation damage caused by the returned products and accessories during the return journey.
- In any case, the compensation cost received by the customer shall not exceed the actual payment price.

• Non-warranty scope

The following conditions are not included in the free maintenance of the warranty:

- The product has exceeded the warranty period;
- Product failure caused by abuse, misuse or accidental damage by Labbox's judgment;
- Product problems caused by ultraviolet rays or direct light;
- It is not the damage caused by after-sales personnel in the repair or disassembly process;
- Damage caused by chemical erosion or long-term improper maintenance;
- Product failure caused by force majeure factors such as natural disasters;
- The operator fails to follow the corresponding operation suggestions and requirements, improper loading and unloading, improper maintenance, and improper operation;
- Failures or damages that are not caused by the quality of the product itself.

Note: Labbox reserves the right to modify the above terms at any time.

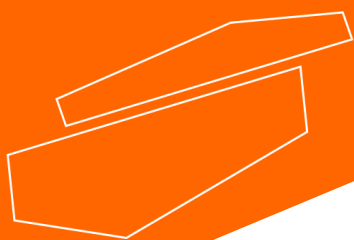

www.labbox.com