



LBX OVV

Vacuum Drying Oven

Please read the User Manual carefully before use, and follow all operating and safety instructions!



user manual

english

User Manual



LBX OVV

Vacuum Drying Oven

Preface

Users should read this Manual carefully, follow the instructions and procedures, and beware of all the cautions when using this instrument.

Service

If help is needed, you can always contact your dealer or Labbox via www.labbox.com (declare an incidence)

Please, provide the customer service representative with the following information:

- Serial number
- Description of the problem
- Your contact information

Warranty

This instrument is guaranteed to be free from defects in materials and workmanship under normal use and service, for a period of 24 months from the date of invoice. The warranty is extended only to the original purchaser. It shall not apply to any product or parts which have been damaged on account of improper installation, improper connections, misuse, accident or abnormal conditions of operation.

For claim under the warranty, please contact your supplier.

Introduction

The Vacuum Drying Oven is widely used in the fields of biochemistry, chemical pharmacy, agricultural research and environment protection for drying and heating powder articles, as well as disinfecting and sterilizing of glass containers. It is specially designed for dryness of heat-sensitive material, decompose-prone and oxidation-prone material in high efficiency.

Features

- High-quality cold-rolled sheet chamber with electrostatic spraying surface ensures the longevity of the product.
- Rectangular working tank maximizes working volume
- PID micro-computer intelligent temperature controller, which has functions of timing, temperature set, setting time, dual screen display, and over-temperature alarm.
- Double-glass door structure, the interior door adopts tempered glass spring bracket structure to ensure good sealability and permissibility, by surpassing pressure of spring, the expanding air is leaked out. The outer door is made of bullet-resisting glass, which makes it easy to observe material inside working room.
- Heat resisting silicon rubber strip by one-time casting mould that greatly improves the seal of the working room.
- Air-tightness adjustable buckle lock ensures excellent vacuum degree.

Working condition

The vacuum oven works under the following conditions:

1. Temperature ranges between 5~40°C;
2. Relative humidity less than 50% RH;
3. Power: voltage 220-240V, frequency 50-60Hz;
4. No violent vibration and corrosive gas surrounding the oven.

Safety instructions

1. Install the outer ground protection to ensure safety of machine and experiment; supply power as the machine nameplate requires.
2. It is forbidden to use this equipment in inflammable and explosive, poisonous and strong corrosive experiments.
3. Make sure the equipment is installed horizontally.
4. Non-professionals are not allowed to disassemble and repair this machine.
5. In normal working processes, if vacuum air bleeder is not fully filled with air or pressure of working room does not reach the constant point, it is not allowed to open the door of working room in any way or by force to prevent accidents.
6. If the treated material is inflammable, make sure the temperature is cooled down below burning point, and then put the air in, or else it will cause oxidation reaction and burning.
7. Read the instruction book before operation.

Product structure diagram and parameters

Structure diagram

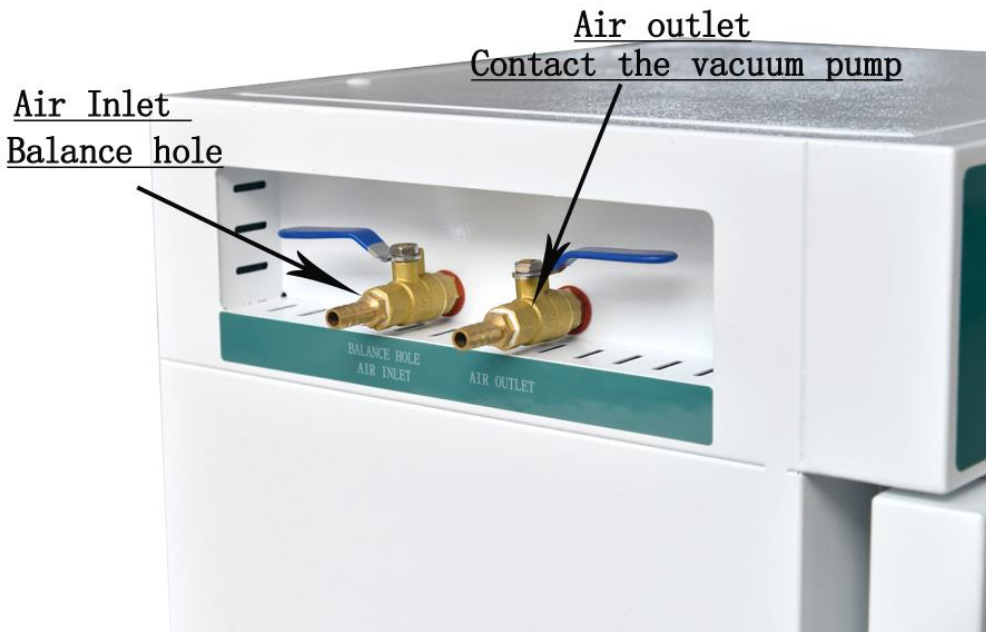

Main technical parameters

Model	DOVV-024-001	DOVV-052-001
Capacity	24 L	52 L
Supply voltage	AC220-240V 50-60Hz	
Power(w)	800W	1400W
Temp. range	RT+10~250°C	
Temp. fluctuation	±1%	
Temp. resolution	0.1 °C	
Heating-up time	80 min	100 min
Useful vacuum degree range	< 133Pa	
Inner chamber	Stainless steel	
Outer shell	Cold rolling steel electrostatic spraying exterior	
Insulation layer	Aluminum silicate fiber	
Heater	Stainless steel electric heating tube	
Observation window	Bullet proof glass, acrylic exterior protection	
Vacuum meter	Pointer type, accuracy class 2.5	
Nozzle diameter	10mm	
Temp. control mode	Two temperature section PID intelligent	
Temp. setting mode	Touch button setting	
Temp. display mode	Upper row: Measuring temperature Lower row: Set temperature	
Timer	0-9999 min	
Sensor	Pt100	
Inner Chamber Size W*L*H(mm)	300×300×270	415×340×370
Exterior Size	480x480x606	560x540x680
Packing Size	590x550x750	704x620x814
NW/GW (kg)	42/52	67/92
Number of shelves	2	2
Load per rack	15 kg	
Shelf space	100 mm	140 mm
Fuse specification	10A	15A

Temperature profile

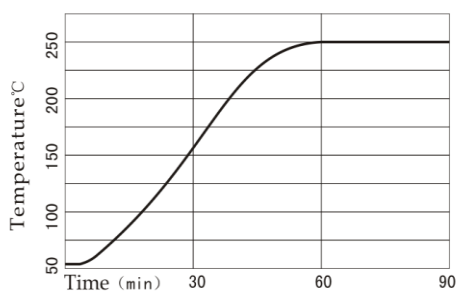

Note: according to the different model type, the warming up time is different

Operational instructions

1. Put the material that needs drying in the container (size of drying material should not over 2/3 of the shelf); then shut off the air bleeder, close the container door and switch on vacuum valve, and next switch on vacuum pump to exhaust air, at the same time, watch vacuum meter. Screw the door handle slightly, anticlockwise running of vacuum meter pointer indicates it is pumping the air out. When the vacuum meter points to -0.1 mpa, close the vacuum valve, and shut off vacuum pump and power.

Note: When vacuum oven is pumping air, close vacuum valve first, and then shut off vacuum pump, otherwise the vacuum pump oil will might up into the workroom.

2. Heating

Turn on the power, and set temperature as needed (find details in meter instruction), then the temperature starts to rise; when temperature inside working room reaches the set point, the heating indication light will go out; in general, working within 120 min, the internal shelf layer goes into constant temperature state.

3. Working time

Decide the drying time according to the humidity of the sample. If the drying time is too long, degree of vacuum will be decreased, then exhaust air again to revert vacuum degree. The operation method is open up the vacuum pump, and then the vacuum valve.

Note: when drying the material with large humidity, add vacuum transition dryer in inlet pipeline of vacuum pump to ensure long service life of vacuum pump.

4. When finished drying, shut off the power, and turn on the air bleeder, after 5 min, it eliminates the vacuum state, then open the door and take the material out.

Note: After eliminating the vacuum, the seal gasket will be sucked to glass door; it is not easy to open the door at once, wait for a moment until the seal gasket returns to natural form, and then open the door.

5. Keep the drying oven clean, wipe the container sealing rubber strip by soft cloth and clear the dirt out; avoid cleaning it by chemical solution to prevent chemical reaction damage on sealing rubber strip.

6. If the oven is unused for a long time, daub neutral grease or Vaseline on galvanized parts to prevent corrosion; cover the oven with plastic dust cap, and store it in the dry room to keep the electric device from getting wet.

Instrument operation instruction

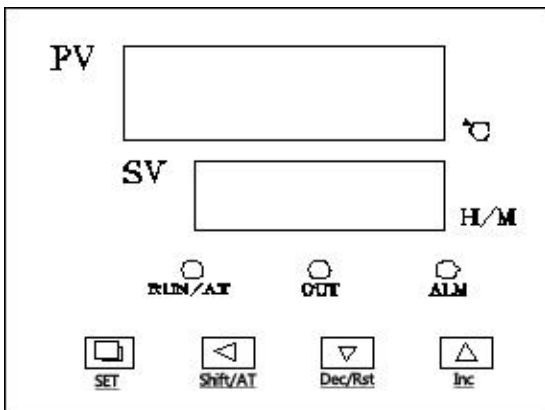

Indicator definition

- 1) "RUN/AT" indicator: This indicator is bright when the controller is running, when the runtime is over, this indicator is not bright. When the controller enters the auto-tuning of PID, this indicator is flashing.
- 2) "OUT" indicator: If the heater output turns on, this indicator is bright, else this indicator is not bright.
- 3) "ALM" indicator: When the over-temperature alarm occurs, this indicator is bright.

Operation and using

1) When the controller is switched on, display windows shows "In index (P, C, K, S)" and the value of the temperature range for 3 seconds, then it starts running.

2) Temperature and time settings:

Press the "Set" button, the controller runs into the temperature setting state. Re-press the "Set" button, the controller runs into the time setting state. In setting state, you can use the "◀", "▼" and "▲" buttons to get the required settings. Press the "set" button again, it returns from the setting state and the settings are saved automatically.

If the time is set as "0", the controller will run continuously, the display window of "SV" will display the set point temperature. If the time set value is not equal "0", the timer will start counting time when the measuring temperature reaches the set point temperature, the display window of "SV" will display the runtime.

Note:

If $E_n = 0$, when the runtime is over, the "sV" window will display "End", the buzzer will sound for 30s, off all outputs; (this is set by default)

If $E_n = 1$, when the runtime is over, the "sV" window don't show "End", the buzzer sounds for 30 seconds, temperature Continue to constant temperature; After the end of operation, long press "shift / run" button for 3 seconds can restart the timer operation. (This must be changed in parameters, check "internal parameter settings" chapter).

(1) The normal display

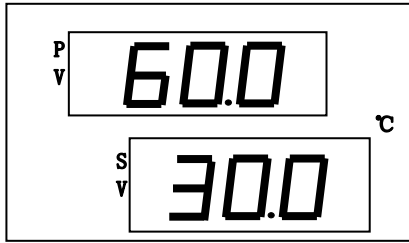

(2) the temperature setting state

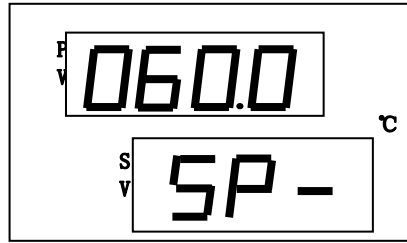

(3) the time setting state

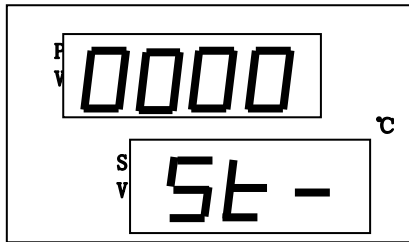

(4) Timing display

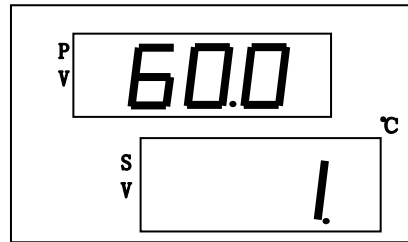

- 3) When temperature alarm, the buzzer will sound and "ALM" lights. If there is a change in temperature setting and over-temperature alarm," ALM" lights up, but no there is no buzzer sound.
- 4) When the buzzer sounds, it can be muted by pressing any button.
- 5) "◀" button: In the setting state, it can shift the set value by pressing the button.
- 6) "▼" button: In the setting state, it can reduce the set value by pressing the button. If press and hold the button, the set value will reduce continuously.
- 7) "▲" button: In the setting status, it can increase the set value by pressing the button. If press and hold the button, the set value will increase continuously.
- 8) In setting state, the controller will return to run status if no key is pressed in one minute.
- 9) If the display window shows "----", it indicates the fault of temperature.

AT function

When the temperature control effect is not ideal for system tuning. Self-tuning process temperature can have bigger overshoot, the users in a system setting before please consider this factor.

In not running state, the controller will enter the auto-tuning of PID by pressing the "◀" button for 6s,"RUN/AT" indicator flashes, it will be not bright when the auto-tuning of PID is completed. In the state, compressor into normally open mode, when the auto-tuning of PID after the end of a group of PID parameter, parameter automatic save and return to the normal mode of operation. When running the auto-tuning of PID, it can be stopped by pressing the "◀" button for 6s again.

In the auto-tuning of PID state, if temperature alarm, no songs buzzer and " ALM" don't light, but heating alarm relay automatic disconnect. And "set" keys to effective. In the system self tuning process regardless of whether there is a constant temperature time setting, controller display window lower always displays the temperature setting value.

Internal parameters settings

Press the “Set” button for 3 seconds, controller will display the password prompt “Lc”. Adjust the password to the required value, then press the “Set” button again, it will run into the internal parameter setting state. if press the “Set” button for another 3 seconds, it will return to the running state.

Parameter list-1:

Parameter indicator	Name	Instruction of the Parameter's function	(Setting range) factory set value
Lc-	Password	when Lc=3 ,then we can see and modify parameters	0
AL-	Alarm setting	When temperature is beyond “SP+AL”, the Alarm indicator turns on. The buzzer sounds and the heater output turns off.	(0~100°C) 5
T-	Control cycle	The heat control cycle of temperature	(1~60S) Note 1
P-	Proportional band	Adjustment of proportional parameter.	(1.0~rH) 30
I-	Integration time	Adjustment of integration parameter.	(1~1000S) 400
d-	Differential time	Adjustment of differential parameter.	(0~1000S) 200
Pb-	Zero point adjust	When the zero error comparatively larger, to update this value should be needed. Pb=measure value –actual value	(-50~50°C) 0
PK-	Full point adjust	When the full point error also comparatively larger, to update this value should be needed. PK=1000× (measure value –actual value) / actual value.	(-999~999) 0
Et-	Timing function	When ET = 0, no timing function; 1 electric start timing, 2 to the value set start timing.	(0~2)

Note 1 : If the selection of relay output, heating control cycle should be selected in 20 seconds, the other models for 5 seconds.

Parameter list-2:

Parameter indicator	Name	Instruction of the Parameter's function	(Setting range) factory set value
Lc-	Password	when Lc=9,then we can see and modify parameters	0
Co-	Turn off the heat output deviation	when“PV≥SP+Co”, Turn off the heating output 。	(0.0~50.0°C) 5.0
Hn-	Constant temperature time mode	0 : minutes time ; 1 : hours time	(0~1) 0
En-	End of operation temperature	En = 0 end of run off output; En = 1 end run to constant temperature;	(0~1) 0
Lt-	Maximum power output	The heating output maximum power percentage;	(0~100)100

Parameter list-3:(LCD series this parameter table as the standard, digital series this parameter table for matching)

Parameter indicator	Name	Instruction of the Parameter's function	(Setting range) factory set value
Lc-	Password	when Lc=23,then we can see and modify parameters	0
Fc	Fahrenheit temperature switch	1: for Fahrenheit temperature display; 0: Celsius temperature display	(0~1)0
bd	internal parameters	Customers should according to the Initial value	(0~1)0
ad	Address	Communication address	(0~32)1
p-t	Print interval	When p-t=0,no print	(0~9999s)0s

English name and parameter indicating the symbol table

Parameters Indicating	SP	St	Lc	AL	T	P	■	d
English Name	SP	St	Lc	AL	T	P	■	d
Parameters Indicating	Pb	Pk	Co	Hn	oP	rH		
	Pb	Pk	Co	Hn	oP	rH		

Fault analysis

Phenomena	Causation	Treatment Method
1.No power supply	1.Plug is poorly contacted or the line is broken	1. Connect the plug and line.
	2. Fuse protector is broken.	2. Change the fuse protector.
2. No temperature rising inside container	1. Low setting temperature	1. Readjust and set temperature
	2. Heater is broken.	2. Change the heater
	3. Temperature controller is broken.	3. Change the temperature controller
	4. Temperature sensor is loose.	4. Screw up the sensor nut.
	5. Temperature sensor is broken.	5. Change the temperature sensor.
3. No vacuum-pumping	1. Air bleeder on panel is on.	1. Close the air bleeder
	2. Air valve on panel is on.	2. Close the vacuum valve.
	3. Vacuum pump exhaust tube is poorly connected.	3. Connect the pump exhaust
	4. Vacuum pump is broken.	4. Change vacuum pump.
	5. The chamber door is not fastened.	5. Fasten the chamber door.
	6. Rubber seal does not work.	6. Change the rubber seal.
	7. Vacuum meter on panel is broken.	7. Change the vacuum meter.
4. Displaying-----	The sensor is broken.	Change the sensor
5. Display STOP	Time-up	Press the program key for 3s to start.
6.It cannot reach - 0.1Mpa	Vacuum pump is burn-in.	Repair or change the parts
7. Vacuum degree is decreasing.	Rubber seal does not work, or the exhaust tube is leaking.	Repair or change the parts
8.Vacuum meter can't back to 0	Vacuum pump is burn-in.	Repair or change the parts
9. Vacuum meter is out of range.	Vacuum pump is burn-in.	Repair or change the parts

Nota importante para los aparatos electrónicos vendidos en España
Important note for electronic devices sold in Spain
Remarque importante pour les appareils électroniques vendus en Espagne

Instrucciones sobre la protección del medio ambiente y la eliminación de aparatos electrónicos:



Los aparatos eléctricos y electrónicos marcados con este símbolo no pueden desecharse en vertederos.
De conformidad con la Directiva 2002/96/ CE, los usuarios de la Unión Europea de aparatos eléctricos y electrónicos, tienen la oportunidad de retornar el instrumento para su eliminación al distribuidor o fabricante del equipo después de la compra de uno nuevo. La eliminación ilegal de aparatos eléctricos y electrónicos es castigada con multa administrativa.

Nota importante para los aparatos electrónicos vendidos en Francia
Important note for electronic devices sold in France
Remarque importante pour les appareils électroniques vendus en France

Informations sur la protection du milieu environnemental et élimination des déchets électroniques :



Les appareils électriques et électroniques portant ce symbole ne peuvent pas être jetés dans les décharges.
En réponse à la réglementation, Labbox remplit ses obligations relatives à la fin de vie des équipements électriques de laboratoire qu'il met sur le marché en finançant la filière de recyclage de Réylum dédiée aux DEEE Pro qui les reprend gratuitement (plus d'informations sur www.recylum.com).
L'élimination illégale d'appareils électriques et électroniques est punie d'amende administrative.

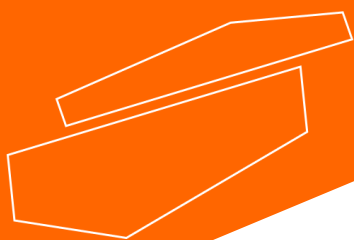

www.labbox.com